

145

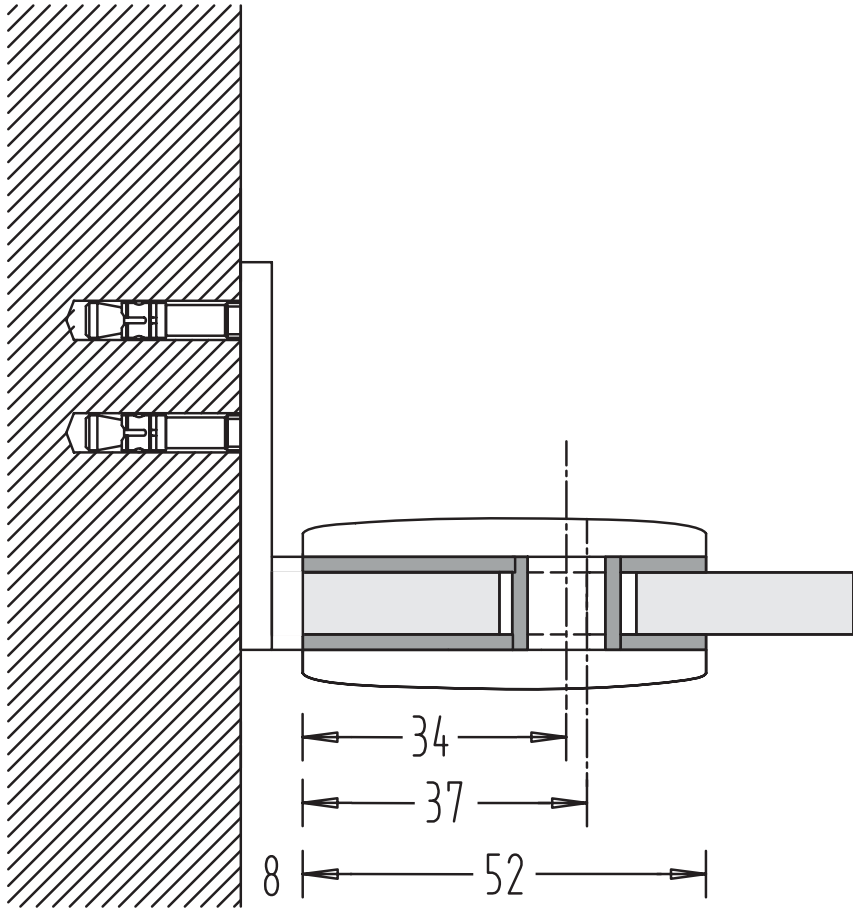

34

37

8 52